

No.1 Share in Japan

ORION[®]
冷熱と真空でイノベーション
Innovating with Thermal Control and Vacuumオリオンクリーンエアシステム
冷凍式圧縮空気除湿装置

Clean Air System

Low Pressure Loss & Energy Saving**Eco-Friendly Refrigerant Applied****Powerful performance in Asia
with heavy duty specification****Best Match for Inverter Compressor & Oil-Free Compressor**

ORION Refrigerated Air Dryer

Feature-Packed Air Dryer for Energy Saving and Stable Productivity,
ORION ARX series (Up to ARX120HL / 180L)

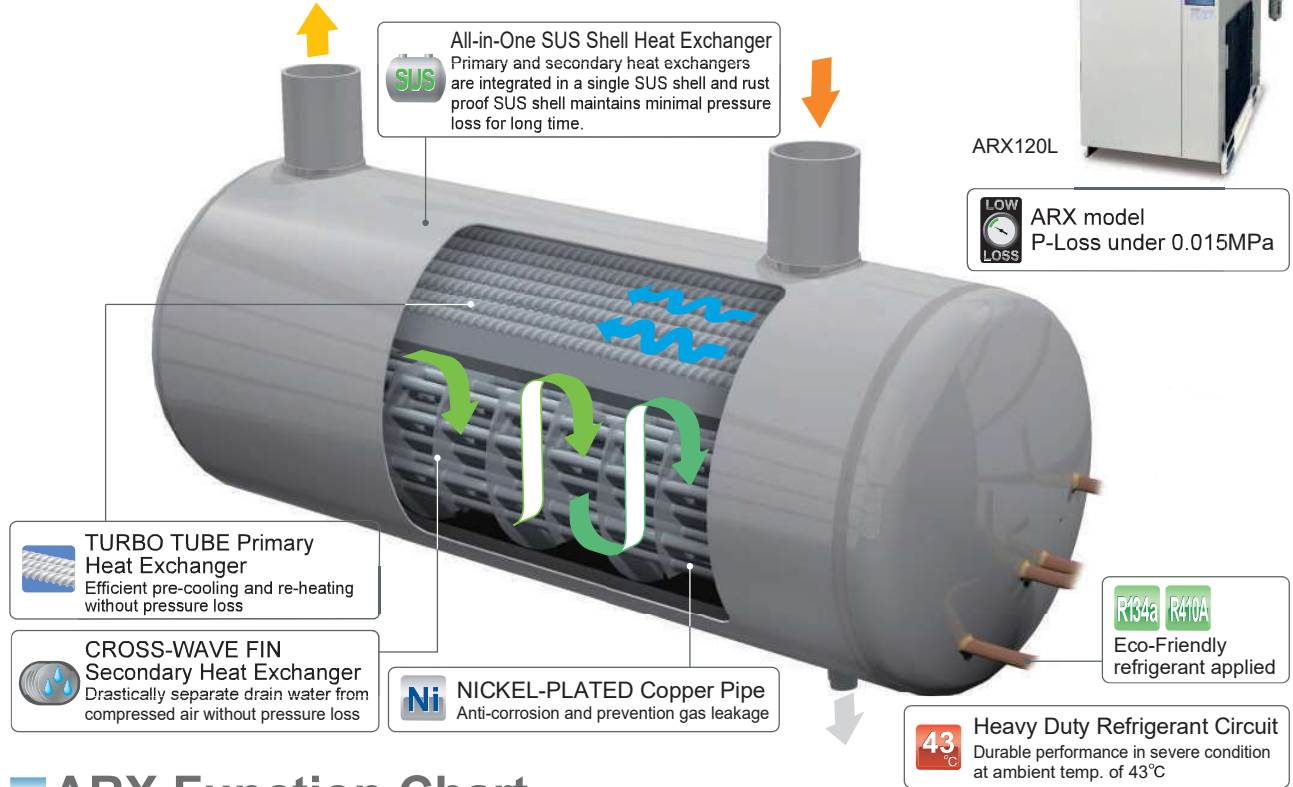







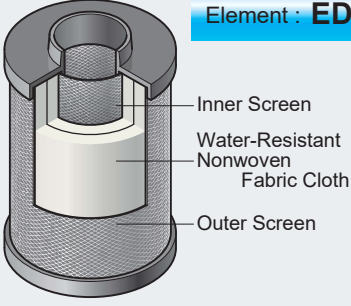
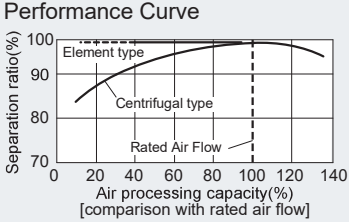

ARX Function Chart

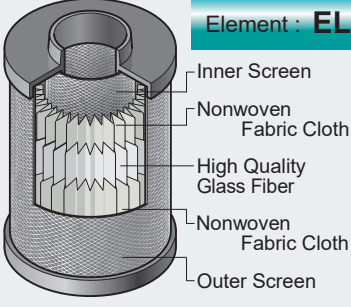
Function	Model : ARX																			
	Standard inlet air temperature model									High inlet air temperature model										
	5J	10J	20J	30J	50J	75J	100J	110L	120L	180L	3HJ	5HJ	10HJ	20HJ	30HJ	50HJ	75HJ	90HL	100HL	120HL
All-in-One SUS Shell Heat Exchanger SUS Shell Heat Exchanger		●	●	●	●	●	●	●	●	●		●								
TURBO TUBE Primary Heat Exchanger	●	●	●	●	●	●	●	●	●	●		●	●	●	●	●	●	●	●	●
CROSS-WAVE FIN Secondary Heat Exchanger	●	●	●	●	●	●	●	●	●	●	●	●	●	●	●	●	●	●	●	●
NICKEL-PLATED Copper Pipe				●	●	●	●	●	●	●			●	●	●	●	●	●	●	●
R134a / R410A Refrigerant	●	●									●	●	●	●	●	●	●	●	●	●
Heavy Duty Refrigerant Circuit	●	●	●	●	●	●	●	●	●	●	●	●	●	●	●	●	●	●	●	●
Condenser Filter		●	●	●	●	●	●	●	●	●		●	●	●	●	●	●	●	●	●
Wide Adjusting Range CCV (capacity control valve)	●	●	●	●	●	●	●	●	●	●	●	●	●	●	●	●	●	●	●	●
Operation Lamp	●	●	●	●	●	●	●	●	●	●	●	●	●	●	●	●	●	●	●	●
Alarm Lamp																				
Evaporating Pressure Gauge		●	●	●	●	●	●	●	●	●		●	●	●	●	●	●	●	●	●
Air Pressure Gauge			●	●	●	●	●	●	●	●		●	●	●	●	●	●	●	●	●
Long Life Fan-Control Switch	●	●	●	●	●	●	●	●	●	●	●	●	●	●	●	●	●	●	●	●
One Touch Open Front Cabinet	●	●	●	●	●	●	●	●	●	●	●	●	●	●	●	●	●	●	●	●
I/F (Remote ON/OFF, Operation Status, Alarm)											Option									
Exhaust Duct											Option									
Float Operated Auto Drain Trap FD6 with Ball Valve																				
Float Operated Auto Drain Trap FD2 with Ball Valve		●	●	●								●	●	●						
Float Operated Auto Drain Trap FD2	●										●									
Disc Operated Auto Drain Trap AD-5 with Ball Valve											●									●

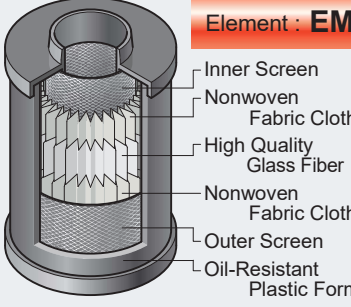
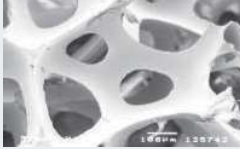
ORION Clean Air Filter

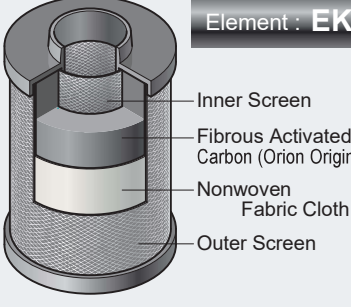
Advanced Technology Packed Clean Air Filter, ORION "AL-Filter" series

Drain Filter DSF-AL		Location*1	Before ARX
	 <p>Element : EDS</p> <ul style="list-style-type: none"> Inner Screen Water-Resistant Nonwoven Fabric Cloth Outer Screen <p>Sectioned Drawing of Element</p>	<p>Water droplet and solid particulate (5µm) removal No water drop in filtration performance Low pressure loss (0.005MPa or less) as pre-Filter Float operated auto drain trap installed</p> <p>P-loss 0.005MPa</p>	 <p>Performance Curve</p> <p>Separation ratio(%) vs Air processing capacity(%) [comparison with rated air flow]</p>
Line Filter LSF-AL		Location*1	After ARX
	 <p>Element : ELS</p> <ul style="list-style-type: none"> Inner Screen Nonwoven Fabric Cloth High Quality Glass Fiber Nonwoven Fabric Cloth Outer Screen <p>Sectioned Drawing of Element</p>	<p>Solid particulate (1µm, 99,999%) removal High quality glass fiber element installed(ELS) Float operated auto drain trap installed Precision different pressure gauge "DG-50(A)" installed (LSF400AL and bigger model)</p> <p>P-loss 0.005MPa (Initial)</p>	<p>High Quality Glass Fiber</p> 
Mist Filter MSF-AL		Location*1	After LSF-AL
	 <p>Element : EMS</p> <ul style="list-style-type: none"> Inner Screen Nonwoven Fabric Cloth High Quality Glass Fiber Nonwoven Fabric Cloth Outer Screen Oil-Resistant Plastic Form <p>Sectioned Drawing of Element</p>	<p>Oil mist (0.01wt ppm) and fine solid particulate (0.01µm, 99,999%) removal Newly developed element installed(EMS) Float operated auto drain trap installed Precision different pressure gauge "DG-50(A)" installed (MSF400AL and bigger model)</p> <p>P-loss 0.01 ~ 0.02MPa</p>	<p>Oil-Resistant Plastic Form</p>  <p>High Quality Glass Fiber</p> 
Carbon Filter KSF-AL		Location*1	After MSF-AL
	 <p>Element : EKS</p> <ul style="list-style-type: none"> Inner Screen Fibrous Activated Carbon (Orion Original) Nonwoven Fabric Cloth Outer Screen <p>Sectioned Drawing of Element</p>	<p>Removes Odor (0.003wt ppm) . Newly developed element "Fibrous Activated Carbon" installed(EKS) Great reduction in amount of loose carbon as compared with previous filters</p> <p>P-loss 0.009MPa</p>	<p>Output Oil Concentration(wt ppm)</p>  <p>MSF-AL vs KSF-AL</p>

All AL-Filter are alumite-treated on the inside surface.

*1 : Please refer to Basic System Example catalog on page 4

ORION Refrigerated Air Dryer ARX Series



Standard inlet air temp. model

Descriptions	Type	ARX										
		5J	10J	20J	30J	50J	75J	100J	110L	120L	180L	
Air Processing Capacity	m ³ /min	0.54	1.0	2.3	4.0	6.4	9.0	12.0	13.0	19.0	26.0	
Inlet Air Temperature	°C	10~50										
Dew Point Temperature	°C	3~15										
Ambient Temperature	°C	2~43										
Operating Pressure	MPa	0.2~1.0										
Dimensions	Height	mm	480	510	610	900	990	1050	1054	1229	1275	
	Depth	mm	450	600	820	960	980	1010	1022	1023	1291	
	Width	mm	180	240	240	300		380	470	592	702	
Mass	kg	18	26	35	44	83	94	106	140	167	233	
Pipe Connections	B	R1/2	R3/4	R1		R1·1/2		R2		R2·1/2		
Power Source		1ph 220V 50Hz						3ph 380V 50Hz				
Power Consumption	kW	0.26	0.27	0.36	0.68	1.7		3.3		3.4	5.0	
Refrigerant		R134a					R410A					

※ Rated condition: Compressed air inlet pressure (gauge pressure): 0.69MPa, Pressure dew point: 10°C, Inlet air temperature: 35°C, Ambient temperature: 30°C
 ※ Air Processing Capacity is converted to the suction air condition (atmospheric, 32°C, 75%RH). ※ Refer to the specifications sheet for further details.

High inlet air temp. model

Descriptions	Type	ARX										
		3HJ	5HJ	10HJ	20HJ	30HJ	50HJ	75HJ	90HL	100HL	120HL	
Air Processing Capacity	m ³ /min	0.32	0.7	1.1	2.8	4.6	7.6	8.8	10.7	14.9	18.4	
Inlet Air Temperature	°C	10~80										
Dew Point Temperature	°C	3~15										
Ambient Temperature	°C	2~43										
Operating Pressure	MPa	0.2~1.0										
Dimensions	Height	mm	480	510	610	900	990	1050	1054	1229	1275	
	Depth	mm	450	600	820	960	980	1010	1022	1023	1291	
	Width	mm	180	240	240	300		380	470	592	702	
Mass	kg	18	26	35	44	83	94	106	140	167	233	
Pipe Connections	B	R1/2	R3/4	R1		R1·1/2		R2		R2·1/2		
Power Source		1ph 220V 50Hz						3ph 380V 50Hz				
Power Consumption	kW	0.27	0.28	0.37	0.74	1.9	2.0	3.7		3.8	4.8	
Refrigerant		R134a					R410A					

※ Rated condition: Compressed air inlet pressure (gauge pressure): 0.69MPa, Pressure dew point: 10°C, Inlet air temperature: 50°C, Ambient temperature: 35°C
 ※ Air Processing Capacity is converted to the suction air condition (atmospheric, 32°C, 75%RH). ※ Refer to the specifications sheet for further details.

Heavy Duty model

Descriptions	Type	ARX										
		2300A	3100A-E	3500A-E	4500A-E	2900A-W	4100A-WE	5300A-WE	7400A-WE			
Air Processing capacity	m ³ /min	23	31	35	45	29	41	53	74			
Inlet Air Temperature	°C	10~60				10~60						
Dew Point Temperature	°C	3~15				3~15						
Ambient Temperature	°C	2~45				2~45						
Operation Pressure	MPa	0.29~1.0				0.29~1.0						
Dimensions	Height	1500			1500	1500	1500	1500	1620			
	Depth	1500			1996	1000	1000	1199	1654			
	Width	802		850	802	802	850	877				
Mass	kg	323	385	380	470	278	350	395	495			
Pipe Connections	FLG	2·1/2B (65A)		3B (80A)		4B (100A)		2·1/2B (65A)	3B (80A)	4B (100A)		
Dual-Drive Eco System		—		○		—		○				
Power Source		3ph 380V 50Hz				3ph 380V 50Hz						
Power Consumption	kW	5.6		10		12		4.2		6.8	9.5	12.5
Recommended Pre-Filter (Option)		DSF2900A		DSF3500A		DSF5300A		DSF2900A	DSF4100A	DSF5300A	DSF8000A	
Refrigerant		R407C				R407C				R410A		

※ Rated condition: Compressed air inlet pressure (gauge pressure): 0.69MPa, Pressure dew point: 10°C, Inlet air temperature for air cooled model: 50°C, Ambient temperature for air cooled model: 35°C, Inlet air temperature for water cooled model: 45°C, Cooling water temperature for water cooled model: 32°C at specified water flow rate. ※ Air processing capacity figures are based on ANR and adjusted to atmospheric pressure, 32°C, 75% RH. ※ Refer to the specification sheet for further details. ※ Please install Drain Filter (DSF) before air dryer to guarantee its performance.
 ※ Air connection flange: JIS 10K FF, No companion flange is attached.

ORION Clean Air Filter



LSF400-AL

MSF400-AL



DSF2900A

DSF4100A

AL Small-size Air Filter

Descriptions	Type		Type									
	DSF/LSF/MSF/KSF		75-AL ^{※1}	150-AL	200-AL	250-AL	400-AL	700-AL	1000-AL	1300-AL ^{※4}	2000-AL ^{※4}	
Air Processing Capacity ^{※2}	0.69MPa	m ³ /min	0.35	1.2	1.8	2.7	3.9	6.6	10.6	13.8	20.0	
Casing Material	Aluminum Die Casting (All AL-Filter are alumite-treated on the inside surface.)											
Operating Range	Fluid		Compressed Air									
	Inlet Air Pressure	MPa	0.05~1.0 (DSF / LSF / MSF 1300AL1, 2000AL1 : 0.1~1.0)									
	Inlet Air Temperature	°C	5~60									
	Ambient Temperature	°C	2~60									
Performance ^{※3}	Filtration		DSF : 5µm and Water Separation Efficiency 99% / LSF :1µm (Filtration Efficiency 99.999%) MSF : 0.01µm (Filtration Efficiency 99.999%) / KSF : Adsorption									
	Outlet Oil Contamination	wt ppm	MSF : 0.01 / KSF : 0.003									
	Pressure Loss	MPa	DSF :Initial 0.005 / LSF :Initial 0.005 / MSF : Initial : 0.01 • Usual 0.02 / KSF : 0.009									
When to replace filter element	One year or pressure loss 0.02 MPa for DSF, 0.035 MPa for LSF/MSF, whichever comes first.											
Connections	Pipe Connections		Rc3/8	Rc1/2	Rc3/4	Rc1	Rc1 • 1/2		Rc2			
	Different Pressure Gauge Connection		Rc1/4									
Mass	kg		1.0	2.0	2.1	2.6	5.0	6.0	6.5	9.0		
Accessories	Filter Element	Type	EDS/ELS EMS/EKS	75	150	200	250	400	700	1000	1300	2000
		Q'ty		1 each								
	Auto Drain Trap		LSF/MFS DSF	NH-503MR built-in, none with KSF						FD2, none with KSF		
	Differential Pressure Gauge			Option			DG-50(A)(LSF • MSF Equipped) / DSF • KSF Option					

※1. KSF available from 150 to 2000. ※2. Air Processing Capacity is converted to the suction air condition (atmospheric, 32°C, 75%RH).

※3. All Performances are tested at standard Air Processing Capacity (0.69MPa), Inlet oil contamination 3 wt ppm(LSF/MSF), 0.01wt ppm(KSF)

※4. Model name of KSF is "KSF1300-AL" and "KSF2000-AL".

※5. Oil concentration is measured in conformity with ISO8573-2 "Compressed air - Part 2 : Test methods for oil aerosol content", not including oil-vapor.

SUS Large-size Air Filter

Descriptions	Type		Type					
	DSF/LSF/MSF/KSF		2900A	3500A	4100A	5300A	6100A	8000A
Air processing capacity	0.69 MPa	m ³ /min	29	35	41	53	61	80
Body and housing	Stainless steel							
Operating Ranges	Fluid		Compressed Air					
	Operating Ranges	MPa	0.1~1.0 (DSF: 0.2~1.0, KSF:0.05~1.0)					
	Inlet Air Temperature	°C	5~60					5~60
	Ambient Temperature	°C	2~60					2~60
Performance	Filtration		DSF : 5µm (Liquid water separation efficiency: 99%) LSF : 1µm (Filtration efficiency: 99.999%) MSF : 0.01µm (Filtration efficiency: 99.999%) KSF : Adsorption by activated carbon fiber					
	Outlet Oil Concentration	wt ppm	MSF : 0.01 KSF : 0.003 ※ Subject to inlet air conditions of the system piping.					
When to replace filter element	One year or pressure loss 0.02 MPa for DSF, 0.035 MPa for LSF/MSF, whichever comes first.							
Air Connection (FLG)			2 • 1/2B (65A), JIS 10K FF	3B (80A), JIS 10K FF		4B (100A), JIS 10K FF		
Mass	kg		26	28		DSF/LSF/MSF : 48 KSF : 46 DSF / LSF / MSF / KSF : 95		
Accessories	Filter Element	Type	EDS/ELS EMS/EKS	1300	2000		2000	
		Quantity		2	2		3	4
	Auto Drain Trap		FD-10-A (DSF)		FD2 (LSF/MSF)	None with KSF		
	Pressure Differential Gauge		DG-50A (Comes standard only with the MSF. Available as an option on other models.)					
Other								Stand

※ Air processing capacity is converted to the suction air condition(at atmospheric pressure, 32deg.C and 75%). ※ Special-order models available with an air pressure specification of 1.0 MPa. ※ Oil concentration is measured in conformity with ISO8573-2 "Compressed air - Part 2 : Test methods for oil aerosol content", not including oil-vapor. ※ Air connection flange : JIS 10K FF, No companion flange is attached. ※ Refer to the specification sheet for further details.

Basic System Examples

Air Quality Notes



Please install ORION genuine Clean Air Filters 'before and after ARX dryer' for the best performance.

Safety Notes

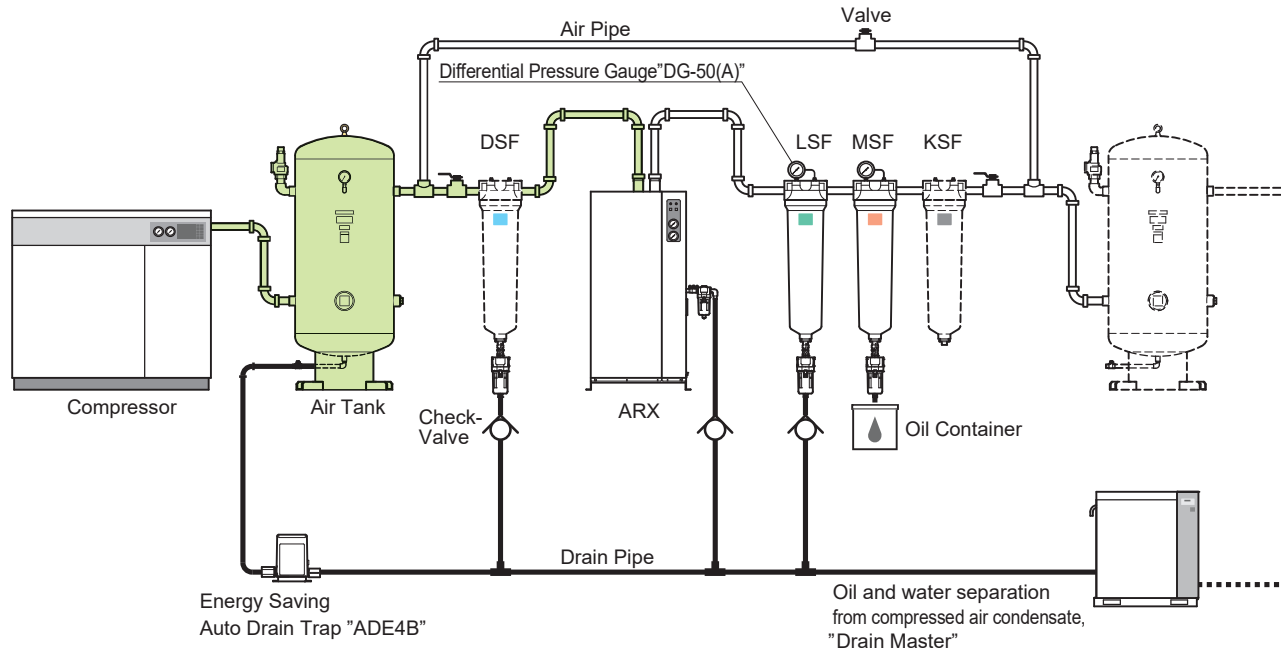
Before operating equipment, please read the operating manual carefully, and only use as indicated. For installation of equipment and required wiring, employ a qualified person or consult with your dealer. Be sure to select equipment which suits your needs. Do not use equipment for purposes other than intended. Doing so can lead to accidents or equipment breakdown.



System	Applications
★ ☆ DSF ARX LSF MSF KSF	General Painting, Precision Machinery Industry, etc
☆ DSF ARX LSF MSF	Standard Pneumatic
ARX LSF MSF	Standard Pneumatic
▲ LSF ARX MSF	▲ Not recommended

- 1) In case no Drain Filter (DSF) before large ARX air dryer (Heavy duty model) does not cover its warranty.
- 2) Please consult with your dealer or ORION directly for further information when compressed air is supplied for medical, food, or clean room use.
- 3) Please set up above ☆ system when Oil-Free compressor is installed.
- 4) Please set up above ★ system when intake air of an air compressor includes large amount of oil droplets.
- 5) ▲ LSF-AL is not recommended to be installed before ARX dryers because it will increase differential pressure and drain water will be accumulated in the differential pressure gauge.
- 6) Please refer to "Compressed Clean Air catalog" (D-AG02 ) for details of "DRAIN MASTER" series.
- 7) SUS pipe and SUS air tank are recommended when Oil-Free compressor is installed (as indicated in Green).
ARX Heat-Exchanger is made of SUS .
- 8) Please install a check valve on exhaust pipe of filter.
- 9) Please consult with your dealer or ORION directly when you are not certain of air tank location (before or after ARX).

Model Selection

1. For Air Dryer

1	Temperature conditions
	Table A : High Inlet Air Temp. Models
	Table B : Standard Air Temp. Models
	Table C : Water Cooled Models
	Table D : Air Cooled Models
Table E : Air Pressure Coefficient	

2	Calculate the necessary air capacity for the model selection.
	Air capacity required = Intake air volume / (A or B or C or D × E)

3	Please select the suitable model from the specification which has bigger Air Processing Capacity (P3) than the air capacity required.
----------	---

Model selection Example

Inlet Air Temp.	60°C	Ambient Temp.	35°C	Air Flow	6m³/min
PDP	10°C	Air Pressure	0.59MPa	Frequency	50Hz

1	From charts, Inlet temp. coefficient → 0.70
	Air Pressure coefficient → 0.93

2	Air capacity required for dryer.
	6 / (0.70×0.93)=9.2m³/min

3	The suitable model to process 9.2m³/min is ARX90HL, as its capacity exceeds the required value.
----------	---

A: Inlet Air Temperature Coefficient (High Inlet Air Temp. Models)

Inlet air temperature (°C)	50			60			70			80			
Outlet dew point (°C)	5	10	15	5	10	15	5	10	15	5	10	15	
Ambient temperature (°C)	30	0.78	1.06	1.27	0.62	0.80	0.92	0.53	0.68	0.82	0.48	0.63	0.79
	35	0.73	1.00	1.21	0.57	0.70	0.86	0.47	0.60	0.74	0.41	0.57	0.71
	40	0.55	0.75	0.91	0.44	0.56	0.66	0.37	0.46	0.55	0.33	0.42	0.51

B: Inlet Air Temperature Coefficient (Standard Inlet Air Temp. Models)

Inlet air temperature (°C)	35			40			45			50			
Outlet dew point (°C)	5	10	15	5	10	15	5	10	15	5	10	15	
Ambient temperature (°C)	25	0.87	1.10	1.31	0.72	0.86	1.05	0.60	0.72	0.86	0.55	0.69	0.76
	30	0.80	1.00	1.20	0.66	0.79	0.96	0.55	0.66	0.79	0.50	0.63	0.70
	35	0.78	0.94	1.15	0.63	0.74	0.92	0.51	0.62	0.74	0.46	0.57	0.65
	40	0.73	0.88	1.08	0.58	0.65	0.86	0.47	0.56	0.68	0.40	0.51	0.58

C: Inlet Air Temperature Coefficient (Heavy Duty / Water cooled Models)

Inlet air temperature (°C)	40			45			50			55			60		
Outlet dew point (°C)	5	10	15	5	10	15	5	10	15	5	10	15	5	10	15
Coefficient	0.88	1.14	1.14	0.77	1.00	1.14	0.66	0.91	1.10	0.59	0.83	0.98	0.54	0.75	0.89

D: Inlet Air Temperature Coefficient (Heavy Duty / Air Cooled Models)

Inlet air temperature (°C)	40			45			50			55			60			
Outlet dew point (°C)	5	10	15	5	10	15	5	10	15	5	10	15	5	10	15	
Ambient temperature (°C)	30	0.85	1.15	1.37	0.83	1.12	1.35	0.78	1.06	1.27	0.67	0.88	1.04	0.62	0.80	0.92
	32	0.82	1.12	1.34	0.80	1.09	1.31	0.76	1.03	1.24	0.64	0.85	1.01	0.60	0.75	0.89
	35	0.79	1.09	1.30	0.77	1.06	1.28	0.73	1.00	1.21	0.62	0.81	0.98	0.57	0.70	0.86
	40	0.60	0.81	0.98	0.58	0.80	0.96	0.55	0.75	0.91	0.47	0.62	0.75	0.44	0.56	0.66

E: Air Pressure Coefficient

Air Pressure (MPa)	0.20	0.29	0.39	0.49	0.59	0.69	0.78	0.88	0.93	1.0
Coefficient	0.67	0.73	0.80	0.87	0.93	1.00	1.07	1.13	1.16	1.20

*Please ask to ORION dealer about coefficient at dew point 3°C *The coefficient is only for reference, please ask ORION dealer about its guaranteed performance.

2. For Air Filter

Calculate the necessary air capacity for the model selection.

$$\text{Air processing capacity} \geq \frac{\text{Desired capacity}}{\text{Pressure correction coefficient}}$$

Pressure Correction Coefficient (inlet pressure)

Pressure (MPa)	0.20	0.29	0.39	0.49	0.59	0.69	0.78	0.88	1.0
Pressure Correction Coefficient	0.38	0.49	0.62	0.75	0.87	1.00	1.06	1.12	1.17

Accessories

Auto Drain Trap

Item	Float operated			Disc operated
	FD2-G3	FD6-G1	FD-10-A	AD-5-G7
Maximum drain flow capacity ※1	10 cm ³ / cycle	30 cm ³ / cycle	80 cm ³ / cycle	450 L / h
Operable pressure range	MPa 0.1 ~ 1.0		0.20 ~ 1.0	0.29 ~ 1.0
Operable temperature range	°C 2 ~ 60			
Processed fluid	Compressed air drain			
Drain release method	Float operated			Disc operated
Connections	Inlet	Rc 1/2		1/2
	Drain outlet	ID ϕ 5.7 ~ 6.0 OD ϕ 8	Rc 3/8	Rc 1/2
Mass	kg 0.3	0.45	1	1.7
Outside dimensions	mm Outside diameter: 63 × length: 178	Outside diameter: 80 × length: 201	Outside diameter: 96 × length: 193	Outside diameter: 86 × length: 198

※1. Drain conditions: Air pressure (gauge pressure): 0.69MPa.

※Indoor specifications (Operable in environment where it would not be exposed to water splash.)

※When setting up drain piping, to prevent back pressure from other traps, be sure to install a check valve. Also install drain traps at each drain port. (Please refer to detail on page 5)

※Refer to the specification sheet for further details.

Differential Pressure Gauge



Various Accessories Available



ORION MACHINERY ASIA CO., LTD.

ORION MACHINERY ASIA PRODUCTS



For inquiries, please contact the following representative:

Important:

- This catalog contains product specifications as of July, 2021.
- Images in this catalog are printed images and actual product colors may differ from the colors herein.
- Product mechanisms, specifications, etc. listed in this catalog are subject to change without notice.
- Designed by Orion Machinery Japan. Assembled in Thailand.